

Magnetic Heads MML 04

Mágnesejek Magnetköpfe

Type / Típus / Typ: MML 04

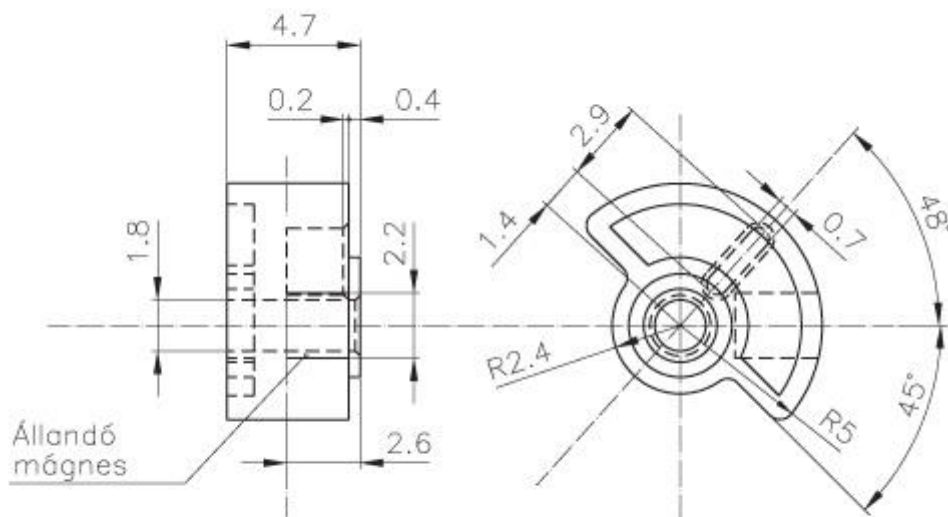

For cass. tape, swingable construction		
Type of the tape	BASF	TP 18 LHS
Tape speed	cm/s	4,75
Erase damping (1 kHz)	dB	min.: 50